

LX-80-8 Level Sensor

RADAR LEVEL SENSOR FOR WATER LEVEL MONITORING

Highlights

- Contactless water level measurement
- The narrowest beam measurement angle on the market (5°)
- RS-232, RS-485 Modbus, SDI-12, and analog 4-20 mA interfaces in all models
- Remote configuration of all instrument parameters through any digital communication interface
- Robust small size IP68 aluminum or stainless steel enclosure

Applications

- Water level monitoring for rivers, channels and lakes
- Early flood warning
- Water reservoir monitoring and irrigation control
- Observing the level of various fluids in the chemical industry
- Level tracking of various fluids and solids in the food industry
- Monitoring levels in waste water, industrial applications, and tanks



Product Description

Geolux LX-80 series of instruments are advanced contactless radar level meters designed for precise distance measurement from the instrument to the surface of the various fluids. This functionality is achieved by transmitting an electromagnetic wave in 80 GHz frequency range (W band), and measuring the frequency shift of the electromagnetic wave reflected from the water surface.

Instruments are characterised by low power consumption, supported by multiple communication interfaces, compatible with Geolux and third-party dataloggers, and support remote configuration of all instrument settings over any available digital communication interface.

Narrow beam width of only 5° allows for simpler installation, and that nearby structures such as bridge railings or pillars do not interfere with the accuracy of the water level measurement.

Detailed Specifications

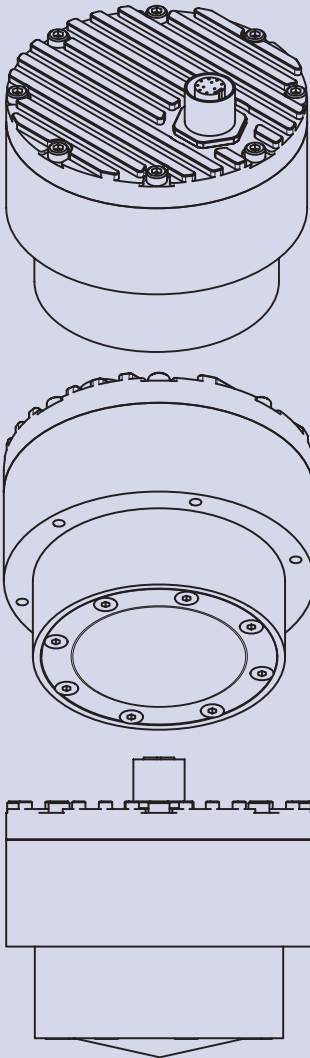

Radar Type	W-band 77-81 GHz FMCW radar
Beam Angle	5°
Detection Distance	8 m
Blind Zone	0.2 m
Resolution	0.5 mm
Accuracy	± 2 mm
Sampling Frequency	1 sps / 10 sps optional
IP Rating	IP68
Serial Interface	1 x serial RS-485 half-duplex 1 x serial RS-232 (two wire interface)
Serial Baud Rate	9600 bps to 115200 bps
Serial Protocols	Modbus, GLX-NMEA
Analog Interface	4-20 mA
Other Interfaces	SDI-12
Connector	M12 circular 12-pin
Input Voltage	9 to 27 VDC
Power Consumption	0.36 W standby 0.15 W; sleep 0.03 W; extended 0.6 W
Maximal Current	< 470 mA
Temperature Range	-40 °C to +85 °C (without heating or coolers)
Enclosure Dimensions	φ 65 mm x H 78 mm

FCC & CE **APPROVED**

MADE IN **EU**

For more information, contact us:

Phone: +385 1 6701 241

E-mail: geolux@geolux.hr

www.geolux-radars.com